

T5-1618

【SPECIFICATIONS】 5Megapixel-Lens

Image Size: 2/3

Focal Length : 16mm
 Maximum Relative Aperture : 1:1.8
 Iris : F1.8~16
 Angle of View : 29.8×22.5°
 Image Size : 8.8×6.6mm (φ11mm)
 Minimum Object Distance : 0.1m (From Front Vertex)
 Resolution : 3.45μm
 TV Distortion : -0.12%
 Optical Back Focal Distance : 13.5mm

Frang Back : 17.526mm
 Operation : Focus : Manual
 Iris : Manual
 Operating Temperature : -10~+50°C
 Mount : C-Mount
 Filter Size : M27 P=0.5
 Size : φ29×41.47mm
 Weight : Approx.75g

【COMPOSITION】

- Lens 1
- Lens Cap 1
- Dust Cap 1

【DIMENSIONS】

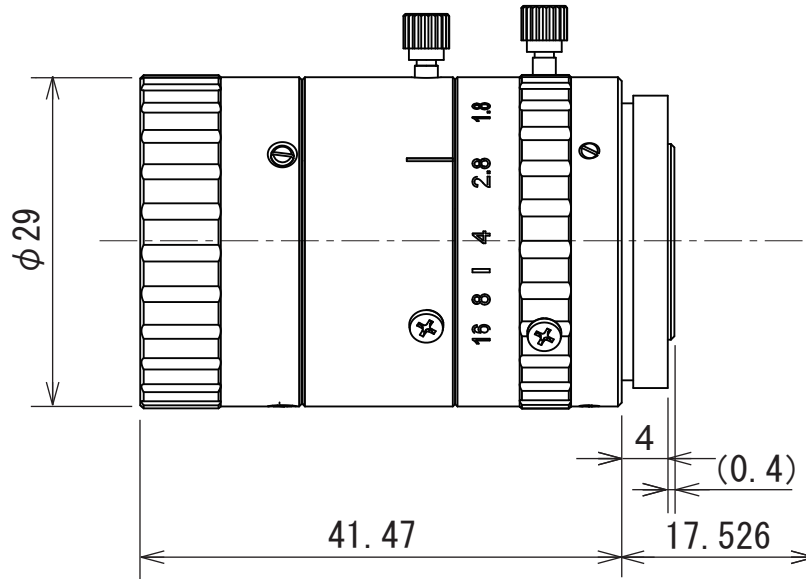

Unit:mm